

**Skalsky, V.R., Pochapsky, Ye.P., Klym, B.P.,
Simakovykh, O.H., Tolopko, Ya.D., Velyky, P.P., and Dolishniy, P.M.**

Karpenko Physical and Mechanical Institute, the NAS of Ukraine, Lviv

DIAGNOSTIC SYSTEM OF WIRELESS ACOUSTIC EMISSION SIGNAL TRANSFER FOR MONITORING THE OIL-AND-GAS FACILITIES



The structure of diagnostic 8-channel system for wireless transfer of acoustic emission information during the monitoring of long-operation objects has been designed. The algorithmic software for hardware system and personal computer, which performs the system control and post-processing of acoustic emission information has been presented. The basic specifications of the system have been described.

Keywords: acoustic emission, system of wireless information transfer, and software.

The acoustic emission systems have a set of disadvantages, with cable communications from the monitoring object to the system being the most crucial one. Recently, wireless technologies have been developed. They are much cheaper and remove the mentioned shortcomings. Among them, the most perfect are radio-telemetric systems as the whole body of transmitting, receiving, and recording hardware that is used to measure, to transmit, to receive and to record, with the help of radio waves, various parameters characterizing the processes in the monitoring object. The use of advanced element base for building these diagnostic systems enables to improve their technical characteristics, to reduce weight, dimensions, and power consumption.

Recently, hardware with the use of radio channel for transmission of acoustic emission data has been designed (for instance, by foreign holdings and corporations *Mistras Group led by RAS* (USA),

Vallen Systeme (Germany), *Brüel&Kjær* (Denmark), *INTERTUNIS*, *Diaton*, *DIAPROMEL* (Russia) [1–10].

RAS (USA) is a leader on the acoustic emission device market. It offers *Radio Channel* recording system [7] based on advanced microprocessors. This wireless system contains a node consisting of primary transducer and module for recording the parameters of acoustic emission signal and transmitting it in the digital form through the radio channel to the receiving station connected to PC via USB. The nodes can operate using autonomous power supply source during several hours.

The system can operate in two modes: a) direct transmission of signals from the nodes to the base station; b) the networking mode, when the nodes transmit the signals to the base station via their neighbors. This mode is the most convenient for monitoring the long objects.

The diagnostic AE hardware of A-Line family 32D (DDM/R) [8] (*INTERTUNIS Ltd*) has been widely used in Russia. The system consists of central block for data collection and processing, on the basis of industrial computer; central two-way

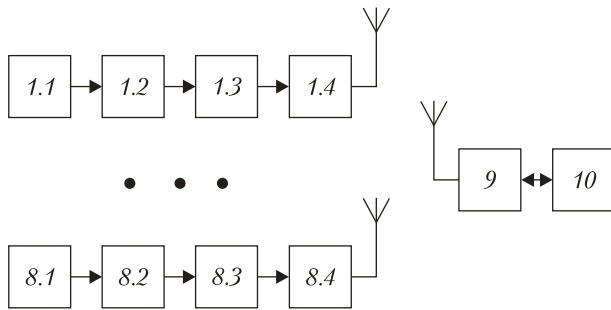

Fig. 1. Flow diagram of 8-channel wireless AE system

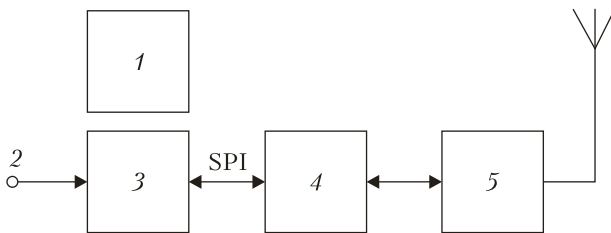

Fig. 2. Flow diagram of PTM

station for receiving data from the AE modules and managing them; two-way station equipped with embedded batteries to ensure up to 8 hour autonomous operation; AE module; and primary transducer. The system ensures data transmission through radio channel within a radius of 500 m from the central station.

Also, there is wireless civil engineering object monitoring system manufactured by *Geotech* [9], which transmits data from the monitoring object without its visual survey. The readings can be transmitted to the user by different ways (for instance, via Internet). Several primary transducers are connected to network thereby forming nodes which have power supply source and can autonomously transmit signals to short distances. Therefore, the central device is put to collect and to store the data from the nodes in database for analysis. In the case of critical situation, warning signal is activated. The central device calibrates primary transducers and reprograms their nodes in order to make the system flexible. The central device has a PC with constant power supply and respective software [10].

In Ukraine, despite some developments in the field of AE [11, 12], there has been no serial production of AE hardware. The experience of operation of AE hardware designed at the Karpenko Physical and Mechanical Institute of the NAS of Ukraine for monitoring the long-operation objects [13], including 4-channel telemetric system [14–16] has been utilized only to formulate the principal requirements for multichannel wireless AE hardware that would enable continuous monitoring of conditions of structure or equipment operating in harmful and explosive environments as well as improvement of effectiveness and quality of monitoring. Among these requirements, there are:

- ✦ To reduce power consumption by primary transceiver module (PTM) (to increase the time of uninterrupted operation);
- ✦ To increase data transmission distance (outside area of probable risk);
- ✦ To enlarge area of object monitoring;
- ✦ To raise accuracy of source coordinates due to improved time synchronization of measuring channels;
- ✦ To raise accuracy of AE signal magnitude due to increasing ADC capacity;
- ✦ To apply the optimization algorithms for antenna installation with real extinction of elastic waves taken into consideration.

Fig. 1 shows a flow diagram of 8-channel wireless AE system that mainly complies with the requirements. It contains the following key nodes: 8-channel AE transducers (1.1–8.1), primary (1.2–8.2) and demodulating (1.3–8.3) logarithmic amplifiers to amplify and demodulate the AE signals from transducer output; primary transceiver modules (1.4–8.4) to select, process, and to transmit the readings in the form of AE signals by radio channel; base transceiver module (BTM) 9 to receive the readings and service data by radio channel and to transmit them to PC via USB port; PC 10 to control the system operation, to process, to store, and to visualize the readings.

PTM flow diagram is given in Fig. 2. Here, 3 is a microcontroller to select, process the AE signals, and to control transmission and receiving of infor-

mation through radio channel. To reduce power consumption by PTM, a microcontroller MSP430 with low consumption MSP430F2618 is used. The blocks 4, 5 are transceiver CC2520 and amplifier CC2591, respectively. Their simultaneous use has enabled to significantly increase range of communication. The module contains an autonomous battery 1. In addition to the above listed components, the PTM has a controller USB FT245RL for data exchange with the PC. The power is supplied from the PC via USB channel.

Enlarging monitored range has been achieved due to the use of 8 acoustic channels. The primary transducers are arranged with real extinction of elastic waves in the material of monitored object and specific shape of the object taken into consideration.

The system is based on *SimpliciTI* network protocol developed by TI corporation and targeted to the networks with low-energy devices (up to 30 devices). It is very easy to use and requires minimum resources of microcontroller. The *SimpliciTI* protocol supports the *star* topology with access point for receiving and sending messages to the ultimate devices. It gets disseminated with open code, does not require any license, and is easily customized to specific problems.

Fig. 3 shows a general view of BTM. The socket for USB cable is located on the side wall. The dimensions are $140 \times 85 \times 40 \text{ mm}^3$.

Data flow chart for BTM as access point to the network is presented in Fig. 4. As the base module is activated, the block 1 initializes the microcontroller. This includes customization of its clock signal system, input-output ports, USB controller, and base timer configuration. Then, program (block 2) initializes transceiver, with SPI channel for interaction between MSP430 and CC2520 and switch of the latter to the receiving mode customized sequentially.

After initialization of hardware part is completed, the initialization of `SMPL_Init(sCB)` (block 3) network starts. The `sCB` parameter is an index for the call function performed in the processor of interruptions when the access point receives the pulse.

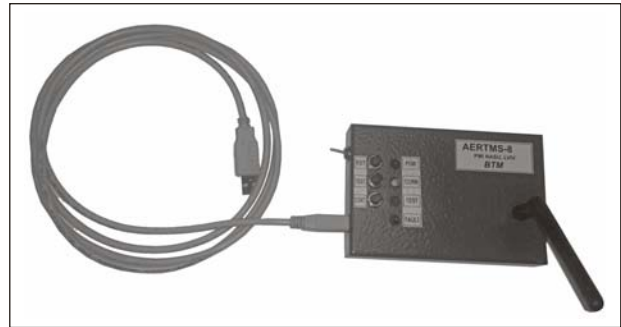

Fig. 3. General view of BTM

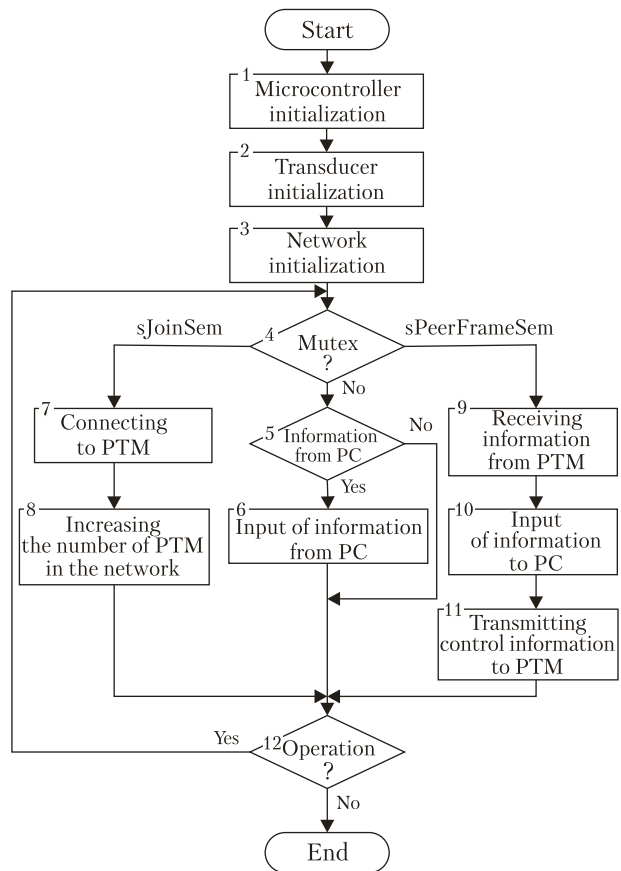

Fig. 4. Data flow chart for BTM

The callback function `sCB` filters the received packages depending on their identifier of communication channel in order to identify the source of package and the request for connecting to the network of new ultimate device. The zero identifier of communication channel means request for



Fig. 5. General view of PTM

connection. If the request is accepted, the access point assigns an identifier within the range from 0×01 to $0 \times 1D$ to the ultimate device connected. In accordance with the identifier of communication channel, the callback function `sCB` defines and increments respective `sPeerFrameSem` or `sJoinSem` semaphore for their processing in the main program body. If `sJoinSem` semaphore (block 4) is set, the function of communication establishment is called (block 7). Then, the number of devices identified by access point increases (block 8), with `sJoinSem` semaphore decrementing.

The `sPeerFrameSem` semaphore is set each time, when BTM receives message from a device in the network, with data received from PTM being transmitted to the PC (blocks 9, 10). The block 11 transmits the control data back to the PTM. This

can be information on the operation mode, discriminating threshold, and the count of base timer for synchronization of all PTMs in the system. If neither of the semaphores is set, the program requests from the PC a probable input of control data (blocks 5, 6).

Fig. 5 shows a general view of PTM. The socket on the front side wall ensures connection to the primary and the demodulating logarithmic amplifiers, the switch is used for activating the PTM operating mode. The block dimensions are $185 \times 85 \times 35 \text{ mm}^3$. The block consists of two boards, the transceiver and the processor ones. Here, a 4.8 V battery with a capacity of $2.7 \text{ A} \cdot \text{hour}$ is located.

The control flow chart of PTM as ultimate device is given in Fig. 6. Here, the block 1 performs additional initialization of ADC (used for digitalizing the AE analog comparator signal envelope in order to determine the moment when the signal exceed the discriminating threshold) and DAC (for setting the discriminating threshold).

After the connection to network (block 3), the PTM operating mode is selected in the block 4. In the test run mode, the test sequence is generated (block 5) with its further transmission to BTM (block 9). The signal is digitalized in the control mode (block 7) at the output of logarithmic amplifier 3 (Fig. 1) in order to control the noise level. In the basic mode, the AE data collection is activated (block 6). This includes the measurement of moments of arrival and magnitude of AE pulses. As time of accumulation expires, the data are sequentially transmitted to BTM with a time lag (block 8) with further receipt of control data from it. The information obtained is used for timer synchronization, setting of discriminating threshold, and selection of operating mode.

Fig. 7 shows a flow chart of subprogram for processing the analog comparator interruptions with one interrupting vector assigned to which CAIFG interrupting flag is tied. It is established on ascending or descending front of comparator signal (defined by CAIES bit of comparator control register CACTL1). If interruption enabling bits CAIE and GIE are set as well, the setting of CAIFG flag

generates a request for interruption. The CAIFG bit can be discharged automatically, when interruption is processed, or by program.

As the comparator is triggered, at the moment when the input signal exceeds the discriminating threshold by descending front, at the output, CAIFG bit is set with a request for interruption generated. While the request is processed, in the block 1 of interrupting subprogram (see Fig. 7), the front on which the interrupting flag is set changes. This enables calling the interrupting subprogram when the information signal drops lower the discriminating threshold. If the signal exceeds the threshold, the reading of PTM timer is sequentially fixed and saved (blocks 3, 4); this reading is deemed to be the moment of AE signal arrival to the primary transducer of respective channel. The block 3 of subprogram initiates the run of 12-bit ADC microcontroller for which a cyclical single-channel transformation mode is set. The signal attenuation below the discriminating threshold leads to reversing the comparator, with the block 6 of subprogram stopping the ADC.

While the transformation result is loaded into the data register ADC12MEM0, ADC12IFG0 interrupting flag is set. If ADC12IE0 and GIE bits are set as well, a request for interruption is generated. The ADC12IFG0 bit is discharged automatically upon the call to ADC12MEM0 register or by program means.

The subprogram for processing ADC interruption saves the transformation result from ADC12MEM0 register and searches for maximum value in the array obtained.

The subprogram for timer interruption corresponds to the interrupting vector of TBCCR0 register for CCIFG bit. The CCIFG interrupting flag is set when the timer reaches the value stored in TBCL0 register. When the timer shifts from value recorded in the TBCL0 register to the zero, the comparator interruption and ADC operation are blocked and data transfer is initiated.

Fig. 8 features time diagrams of transceiver operation showing the principle of PTM timer synchronization. After the completion of AE data

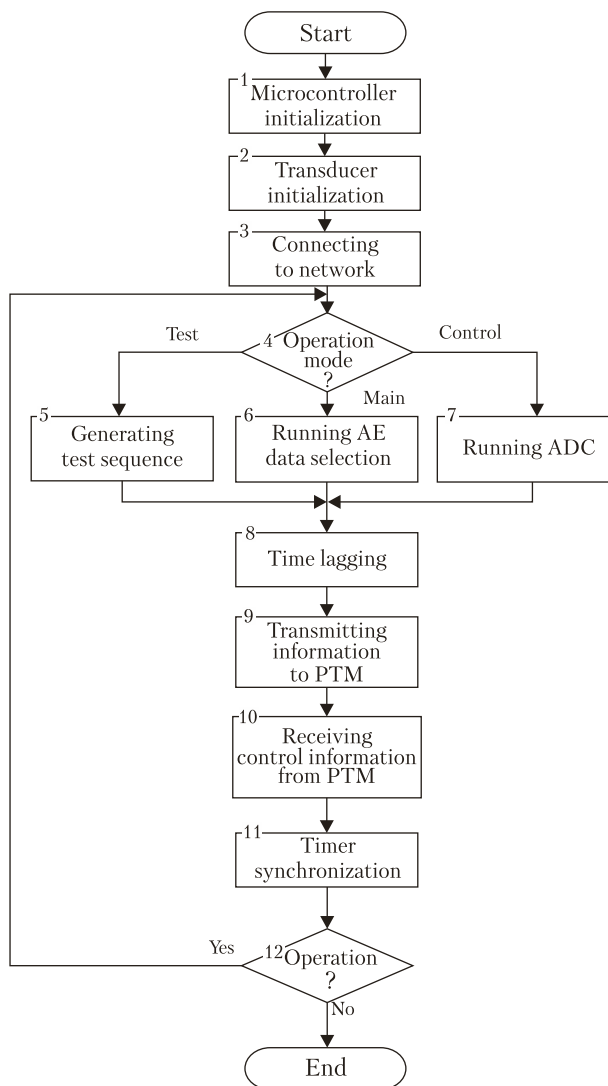

Fig. 6. PTM control flow chart

accumulation, during time T_{ac} , the PTM transceivers are switched sequentially for time T_t from the hibernating mode to the transmitting one (Fig. 8, a, b, c).

The format of package data component transmitted to BTM is given in Fig. 9. The PTM number is stored in the first byte, the number of AE pulses recorded is kept in the second byte. Three bytes are allocated for time of pulse arrival and two ones for the pulse magnitude. The size of data array cannot exceed 52.

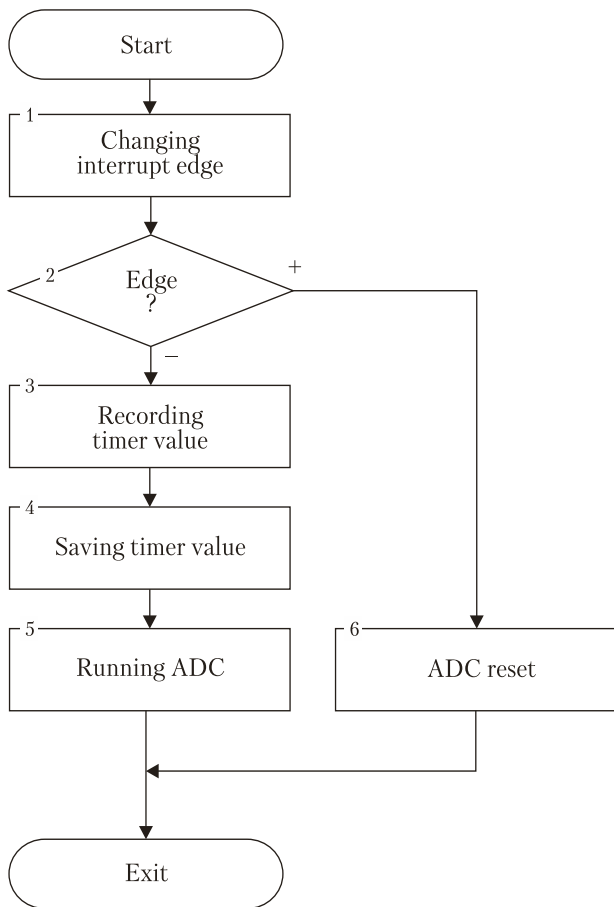

Fig. 7. Control flow chart of comparator interruption subprogram processing

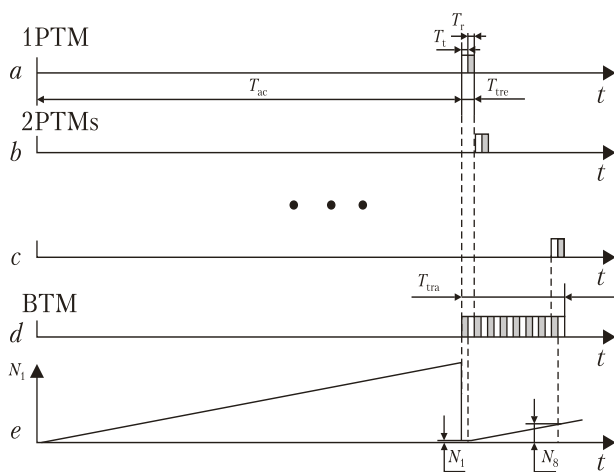

Fig. 8. Time diagrams of transceiver operation

PTM no.	Data volume	Arrival time of the 1 st AE pulse	1 st AE pulse magnitude	...	Arrival time of the N th AE pulse	N th AE pulse magnitude
1 byte	1 byte	3 bytes	2 bytes	...	3 bytes	2 bytes
n ≤ 52						

Fig. 9. Structure of information component of the package transmitted from the PTM to the base

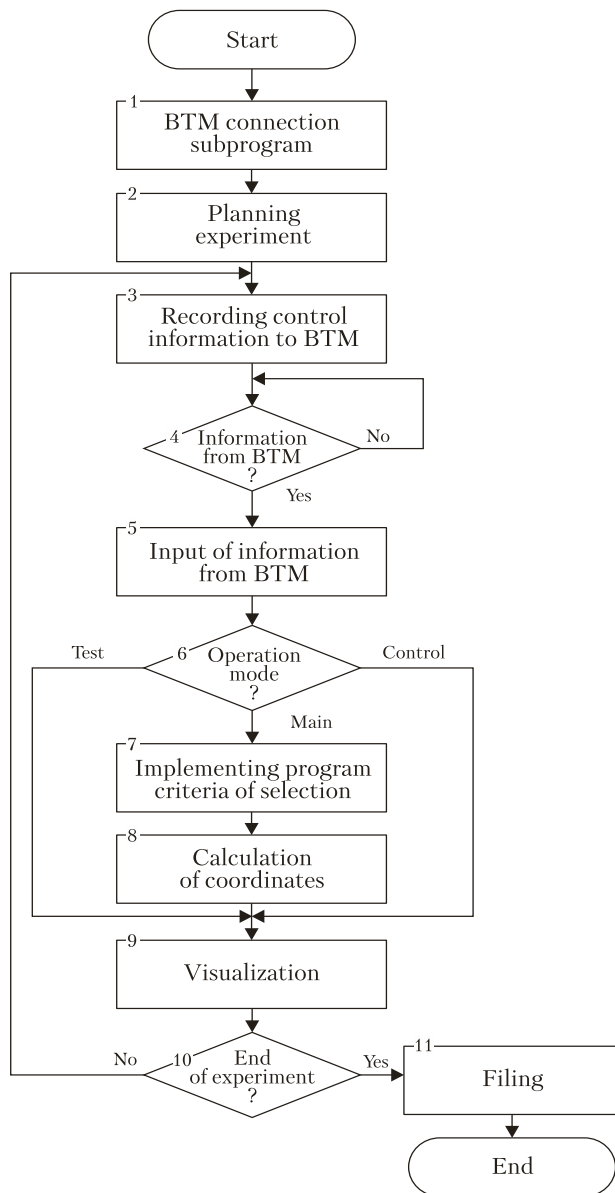

Fig. 10. The flow chart of software for radio-telemetric system

After the transmission is completed, the transceiver of each PTM is switched to the receiving mode. During time T_r (Fig. 8, *a*), the control data from BTM are received (Fig. 8, *d*). Among these data, there is the time count N_i ($i=1, \dots, 8$) of base timer (Fig. 8, *e*) used for synchronization of every PTM timer.

The PTM transceiver operates in the active mode during one hour only

$$T_{tre} = T_t + T_r, \quad (1)$$

the rest of time, it is in the hibernating mode. This approach enables to reduce significantly the consumption. The base transceiver exchanges information with peripheral devices during time

$$T_{tra} = T_{tre} * 8, \quad (2)$$

(Fig. 8, *d*), for the rest of time, it waits information from PTM.

The software for system blocks was developed in IAR Embedded Workbench IDE that is a powerful mean of software design for the MSP430 microcontrollers.

The flow chart of software for PC, which controls the 8-channel radio-telemetric AE system and is destined for storage, processing, and visualization of diagnostic information is given in Fig. 10.

In the block 1 of the program, the BTM is connected to PC through USB port. The block 2 initializes global variables of the program using *ini*-file. Here, it is possible to set the required number of AE channels to be used, type of monitoring object (line, plane, cylinder, sphere), noise discriminating threshold for AE channels, AET coordinates, as well as parameters for tuning of radio channel (output and amplification of transceiver).

The block ensures the planning of experiment aimed at effective selection of AE signal. The file where the experiment data will be stored is assigned with name; the following main parameters of PTM and BTM system are set, computed or measured depending on the specific conditions of experiment:

1) Discriminating threshold U_p of AE channel signal;



Fig. 11. General view of wireless AE diagnostic system

2) Output of PTM and BTM radio transmitter (measured, depends on maximum distance between the PTM and BTM);

3) PTM and BTM radio transmitter amplification (measured). Here, depending on type and dimensions of the monitoring object, the reference point of coordinated is chosen, AET location is set and its coordinates are determined.

The acoustic wave speed in the monitoring object is set a priori or measured. It is a necessary input parameter of algorithm for computing the AE source coordinates.

The block selects one of the four operating modes:

1) The basic mode for selection, initial processing, accumulation, visualization, and storage of readings represented as AE signals during the monitoring of important industrial objects and structures;

2) The control mode;

3) The test mode;

4) The settings mode.

The block 3 organizes recording of control data in BTM; thereafter, the program switches to the mode of waiting for information from BTM (block 4). As the confirmation receipt is received, the programs switches to the block 5 that organizes sequential input of data packages from BTM takes

place. The program branching depends on the selected mode in the block 6.

In the basic mode, the block 7 verifies the input data with respect to their reference to the real AE sources by a set of program criteria [17]. For the RF modulator combinations that comply with the criteria for acoustic antenna geometry, the AE source coordinates are computed in the block 8.

The block 9 visualizes the processing results in the coordinate system that corresponds to the type of location (linear, planar, cylindrical, or spherical) and selected antenna configuration. In the block 10, the decision on continuation or termination of experiment is made. In the case of continuation, the control shifts to the block 3 again. The system is ready for the next data input from PTM. Otherwise, the block 11 records the input data to file and exits the program. The file of data obtained in this mode contains information on magnitudes and moments of appearance of AE pulses of 8 PTM and AE source coordinates in the coordinate system corresponding to selected type of location.

If the block 2 selects the test or the control mode, the block 6 switches control to the block 9 where the data obtained are visualized in accordance with test saw-tooth sequence or noise level at the output of logarithmic amplifier. The latter is used for estimating the noise level at the output of envelope detectors in PTM's AE channels in order to set the optimal level of their discrimination during the experiment planning.

The settings mode is used at the stage of BTM and PTM configuration. It foresees the verification of correctness of block reaction on various directives (instructions) sent by PC through USB port.

The software was developed in DELPHI. The multi-window user interface includes the main menu, toolkit, standardized dialogue boxes, and popup help.

Fig. 11 shows a general view of packed wireless system blocks. It consists of 8 blocks of PTM, base block of BTM, imitator block, and amplifier blocks.

Basic Technical Parameters of the System Designed

Amplification factor of primary amplifier	35 dB
Maximum amplification factor of logarithmic amplifier	92 dB
Frequency of AE signal envelope discretization	0,2 MHz
ADC розрядність of AE channel	12
Accuracy of measurement of AE signal arrival time	1 μ s
PTM data package volume	52 bytes
Structure of data package	Number of PTM, Number of AE pulses recorded (≤ 10), their magnitude and time of arrival
Time of AE data accumulation in PTM	up to 1 s
PTM running time	170 hours
Radiofrequency range	2400 – 2483.5 MHz
Transmission distance	100 m
Dimensions:	
PTM:	170 \times 83 \times 24 mm;
BTM:	125 \times 83 \times 24 mm

The system has been tested under laboratory conditions and got metrological certification.

CONCLUSIONS

1. A structure for 8-channel wireless AE system for monitoring the long-operation objects has been proposed.
2. A software for the system hardware and the PC controlling the system and post-processing of AE data has been developed.
3. The designed wireless AE system matches the world cutting-edge counterparts in terms of both the technical parameters and the software.

REFERENCES

1. *Physical Acoustics Corporation* [Virtual Resource]. Access Mode. URL: <http://www.pacndt.com>.
2. *Vallen Systeme: The Acoustic Emission Company* [Virtual Resource]. Access Mode. URL: <http://www.vallen.de>.
3. *Briuel&Kjaer* [Virtual Resource]. Access Mode: URL: <http://bksv.com>.
4. *IU INTERJuNIS. Sistemy promyshlennogo monitoringa* [Jelektronnyj resurs]. Rezhim dostupu: URL: http://interunis.ru/products/ae_sistemi/ [in Russian].
5. *Akusticheskaja jemissija, NPF Diaton* [Jelektronnyj resurs]. Rezhim dostupu: URL: <http://www.diatontest.ru/index.htm> [in Russian].

6. DIAPROMEL. Diagnosticheskaja i promyshlennaja jelektronika [Jelektronnyj resurs]. Rezhim dostupu: URL: <http://www.diapromel.narod.ru> [in Russian].
7. Sistema registracii AJe «Radiokanal» [Jelektronnyj resurs]. DIAPAK. Rezhim dostupu: URL: <http://www.diapac.ru/Wireless.php/> [in Russian].
8. Akustiko-jemissionnye sistemy A-Line 32D (DDM/R) [Jelektronnyj pecypc]. Rezhim dostupu: URL: http://www.avek.ru/equipment/?section_id=107&item_id=841 [in Russian].
9. Avtomatizirovannaja ocenka sostojanij konstrukcij zdanij i sooruzhenij [Jelektronnyj resurs]. GEOTEK. Rezhim dostupu: URL: <http://www.npp-geotek.ru/monitoring/> [in Russian].
10. Apparatnaja chast' sistemy besprovodnoj svyazi OOO «Geotek» [Jelektronnyj resurs]. Geotek. Rezhim dostupu: URL: <http://www.npp-geotek.ru/monitoring/articles/wireless/wireless.php> [in Russian].
11. Nedoseka A.Ja., Nedoseka S.A., Jaremenko M.A. i dr. O nepreryvnom monitoringe hranilishh zhidkogo ammiaka. *Avtomatičeskaja svarka*. 2004, N 2: 10–17 [in Russian].
12. Nedoseka A.Ja., Nedoseka S.A., Jaremenko M.A. i dr. Ob opyte primenenija AJe tehnologii pri nepreryvnom monitoringe oborudovanija Odesskogo priportovogo zavoda. *Tehnicheskaja diagnostika i nerazrushajushij kontrol'*. 2008, N 2: 85–95 [in Russian].
13. Skal's'kij V.R., Klim B.P., Plahtij R.M. ta in. Portativna sistema 8KOR-8M dlja vimirjuvannja ta analizu signaliv akustichnoi emisii. *Nauka innov*. 2010, 6(3): 20–29 [in Russian].
14. Skal's'kij V.R., Klim B.P., Pochaps'kij Є.P. ta in. Dvo-procesorna akustiko-emisijna telemetrična sistema. *Nauka innov*. 2011, 7(6): 33–43 [in Russian].
15. *Pat. Ukraïny № 100073: G01N29/14*. Sposib radiotelemerichnoi peredachi akustyko-emisijnoi informacii. Skal's'kij V.R., Nazarchuk Z.T., Klym B.P. ta in. [in Ukrainian].
16. *Akustyko-emisijna telemetrična systema diagnostuvannja velykogabarytnyh ob'ektiv*. V.R. Skal's'kij, B.P. Klym, Je.P. Pochaps'kij ta in. VI Mizhnarodna nauko-ve tehnichna konferencija «Suchasni pryklady, materialy i tehnologii» dlja nerujnivnogo kontrolju i tehnichnoi' diagnostyky mashynobudivnogo i naftopromyslovogo obladnannja» (29 lystopada – 2 grudnja 2011, Ivano-Frankivs'k, Ukraïna). Ivano-Frankivs'k, 2011: 73–77 [in Ukrainian].
17. Nazarchuk Z.T., Skal's'kij V.R., Pochaps'kij Je.P. *Tehnologii' vidboru ta opracjuvannja nyz'koenergetychnyh diagnostychnyh sygnaliv*. Kyiv: Nauk. dumka, 2014 [in Ukrainian].

В.Р. Скальський, Є.П. Почапський,
Б.П. Клим, О.Г. Сімакович, Я.Д. Толопко,
П.П. Великий, П.М. Долишній

Фізико-механічний інститут
ім. Г.В. Карпенка НАН України, Львів

ДІАГНОСТИЧНА СИСТЕМА
БЕЗДРОТОВОЇ ПЕРЕДАЧІ СИГНАЛІВ
АКУСТИЧНОЇ ЕМІСІЇ
ДЛЯ МОНІТОРИНГУ ОБ'ЄКТІВ
НАФТОГАЗОВОГО КОМПЛЕКСУ

Розкрито структуру діагностичної 8-канальної системи бездротової передачі акустико-емісійної інформації під час моніторингу об'єктів тривалої експлуатації. Наведено результати розробки програмно-алгоритмічного забезпечення для апаратної частини системи і для персонального компютера, який здійснює управління системою та постобробку акустико-емісійної інформації. Наведено основні технічні характеристики системи.

Ключові слова: акустична емісія, система бездротової передачі інформації, програмне забезпечення.

В.Р. Скальський, Е.П. Почапский,
Б.П. Клим, О.Г. Симакович, Я.Д. Толопко,
П.П. Великий, П.М. Долишній

Физико-механический институт
им. Г.В. Карпенко НАН Украины, Львов

ДИАГНОСТИЧЕСКАЯ СИСТЕМА
БЕСПРОВОДНОЙ ПЕРЕДАЧИ СИГНАЛОВ
АКУСТИЧЕСКОЙ ЭМИССИИ
ДЛЯ МОНИТОРИНГА ОБЪЕКТОВ
НЕФТЕГАЗОВОГО КОМПЛЕКСА

Предложена структура диагностической 8-канальной системы беспроводной передачи акустико-эмиссионной информации во время мониторинга объектов длительной эксплуатации. Представлены результаты разработки программно-алгоритмического обеспечения для аппаратной части системы и для персонального компьютера, осуществляющего управление системой и постобработку акустико-эмиссионной информации. Приведены основные технические характеристики системы.

Ключевые слова: акустическая эмиссия, система беспроводной передачи информации, программное обеспечение.

Received 15.06.15